

C71602

INSTALLATION INSTRUCTIONS SHEET

START FROM HERE

- Make sure power is completely off at the fuse box.
- Have your fixture installed by a qualified licensed electrician
- Prepare everything in clear area.
- Wear gloves at all times during this installation.
- Read instructions carefully before you start assembly.
- Keep this instruction sheet for future reference.

Technical Support: 1-844-628-8368

Please Note:

- All Matteo Lighting fixtures come with pre-wired module(s).
- Unless instructed to do so, please do not touch any part of the module(s) as any unnecessary contact with the module could cause permanent damage.

THIS LUMINAIRE MUST BE MOUNTED OR SUPPORTED IN A JUNCTION BOX
*CE LUMINAIRE DOIT ÊTRE MONTÉ OU SUPPORTÉ DANS UNE BOÎTE
DE JONCTION*

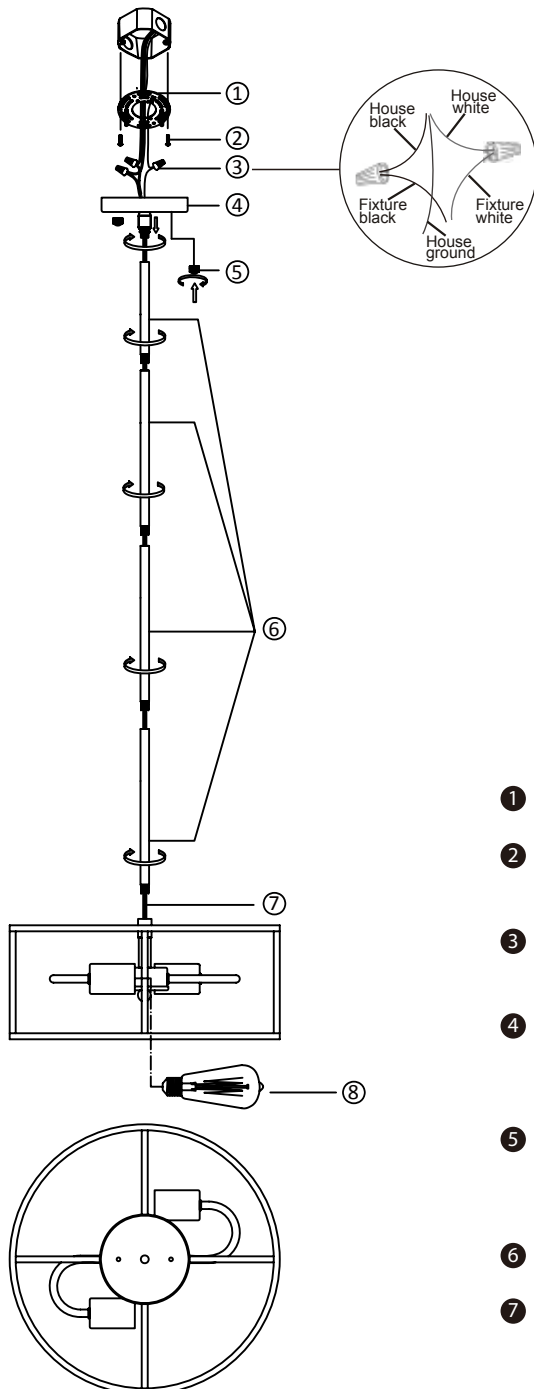

- 1 Ensure main supply is switched off.
- 2 Fit the mounting bracket(1) onto conjunction box with machine screw(2).
- 3 Make wire(7) across rods(6), canopy(4) in order, and screw down all rods.
- 4 Connect wires according to color (White to White, Black to Black). Connect all earth plug together onto the crossbar with green screw to tight(3).
- 5 Hold the fixture and aim the hole on canopy at the screw on mounting bracket, and fit the fixture onto bracket with finials(5).
- 6 Install the lamps(8) firmly into lampholder.
- 7 Reconnect power.